

- ★ Super Low Gate Charge
- ★ 100% EAS Guaranteed
- ★ Green Device Available
- ★ Excellent CdV/dt effect decline
- ★ Advanced high cell density Trench technology

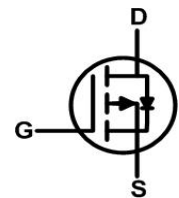
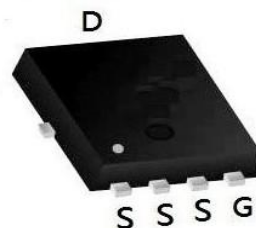
Product Summary

BVDSS	RDSON	ID
-30V	3.5mΩ	-90 A

Description

The XXW90P03F is the high cell density trenched P-ch MOSFETs, which provide excellent RDSON and gate charge for most of the synchronous buck converter applications.

The XXW90P03F meet the RoHS and Green Product requirement, 100% EAS guaranteed with full function reliability approved.

PRPAK5X6 Pin Configuration

Absolute Maximum Ratings (T_A= 25°C, unless otherwise noted)

Parameter		Symbol	Value	Unit
Drain-Source Voltage		V _{DS}	-30	V
Gate-Source Voltage		V _{GS}	±20	V
Continuous Drain Current	T _C =25°C	I _D	-90	A
	T _C =100°C		-57	
Pulsed Drain Current ¹		I _{DM}	-360	A
Single Pulse Avalanche Energy ²		EAS	125	mJ
Total Power Dissipation	T _C =25°C	P _D	60	W
Operating Junction and Storage Temperature Range		T _J , T _{STG}	-55 to 150	°C

Thermal Characteristics

Parameter	Symbol	Value	Unit
Thermal Resistance from Junction-to-Ambient ³	R _{θJA}	55	°C/W
Thermal Resistance from Junction-to-Case	R _{θJC}	2.08	°C/W

Electrical Characteristics ($T_J = 25^\circ\text{C}$, unless otherwise noted)

Parameter	Symbol	Test Conditions	Min.	Typ.	Max.	Unit	
Static Characteristics							
Drain-Source Breakdown Voltage	$V_{(BR)DSS}$	$V_{GS} = 0V, I_D = -250\mu A$	-30	-	-	V	
Gate-body Leakage current	I_{GSS}	$V_{DS} = 0V, V_{GS} = \pm 20V$	-	-	± 100	nA	
Zero Gate Voltage Drain Current	I_{DSS}	$V_{DS} = -30V, V_{GS} = 0V$	$T_J = 25^\circ\text{C}$	-	-	-1	μA
			$T_J = 100^\circ\text{C}$	-	-	-100	
Gate-Threshold Voltage	$V_{GS(th)}$	$V_{DS} = V_{GS}, I_D = -250\mu A$	-1.0	-1.6	-2.5	V	
Drain-Source On-Resistance ⁴	$R_{DS(on)}$	$V_{GS} = -10V, I_D = -30A$	-	3.5	4.5	m Ω	
		$V_{GS} = -4.5V, I_D = -15A$	-	4.8	6.2		
Forward Transconductance ⁴	g_{fs}	$V_{DS} = -10V, I_D = -30A$	-	90	-	S	
Dynamic Characteristics⁵							
Input Capacitance	C_{iss}	$V_{DS} = -15V, V_{GS} = 0V, f = 1MHz$	-	5070	-	pF	
Output Capacitance	C_{oss}		-	695	-		
Reverse Transfer Capacitance	C_{rss}		-	580	-		
Gate resistance	R_g	$f = 1MHz$	-	4	-	Ω	
Switching Characteristics⁵							
Total Gate Charge	Q_g	$V_{GS} = -10V, V_{DS} = -15V, I_D = -30A$	-	146	-	nC	
Gate-Source Charge	Q_{gs}		-	21.5	-		
Gate-Drain Charge	Q_{gd}		-	39	-		
Turn-On Delay Time	$t_{d(on)}$	$V_{GS} = -10V, V_{DD} = -15V, R_G = 3\Omega, I_D = -30A$	-	23	-	ns	
Rise Time	t_r		-	15	-		
Turn-Off Delay Time	$t_{d(off)}$		-	129	-		
Fall Time	t_f		-	28	-		
Drain-Source Body Diode Characteristics							
Diode Forward Voltage ⁴	V_{SD}	$I_S = -30A, V_{GS} = 0V$	-	-	-1.2	V	
Continuous Source Current	I_S	$T_C = 25^\circ\text{C}$	-	-	-90	A	

Note :

1. Repetitive rating, pulse width limited by junction temperature $T_{J(MAX)} = 150^\circ\text{C}$
2. The EAS data shows Max. rating . The test condition is $V_{DD} = -25V, V_{GS} = -10V, L = 0.1mH, I_{AS} = -50A$
3. The data tested by surface mounted on a 1 inch² FR-4 board with 2OZ copper, The value in any given application depends on the user's specific board design.

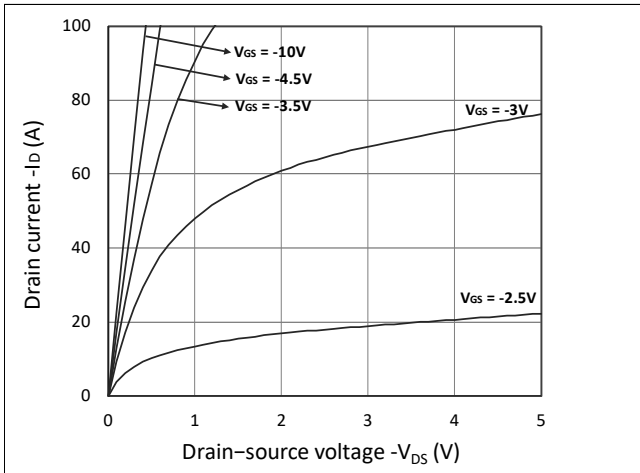
Typical Characteristics


Figure 1. Output Characteristics

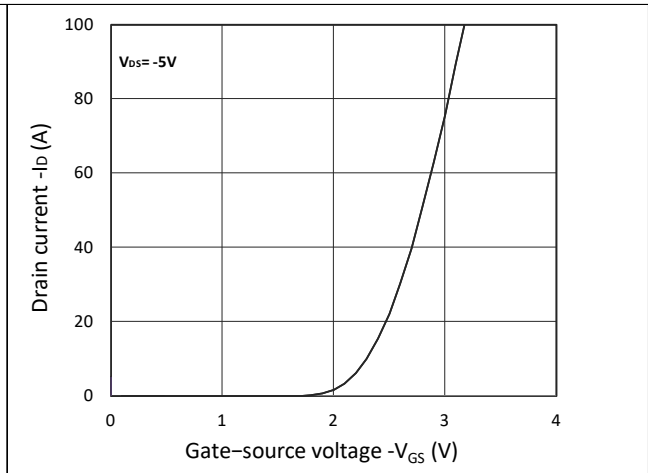


Figure 2. Transfer Characteristics

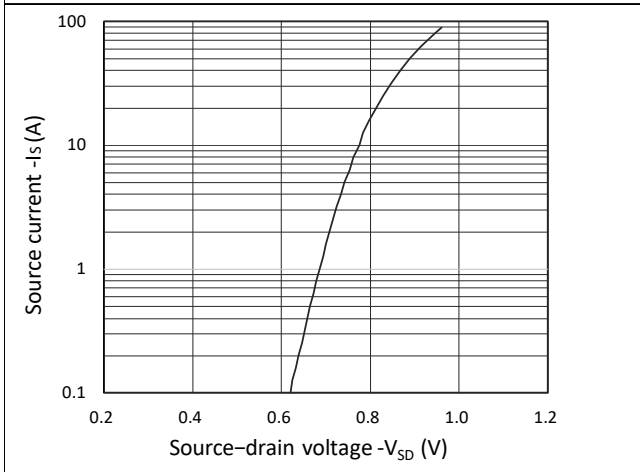
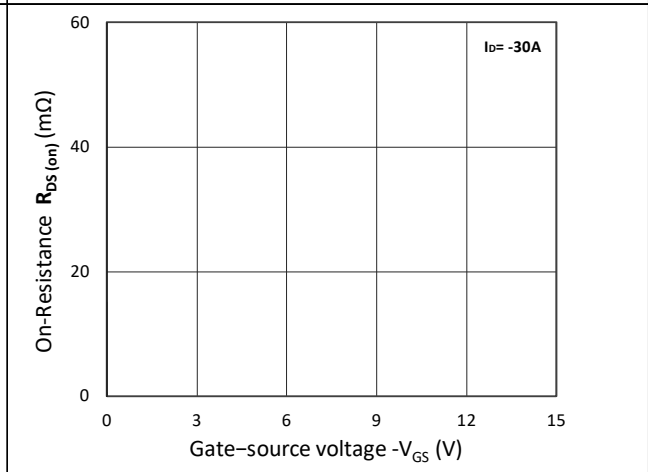
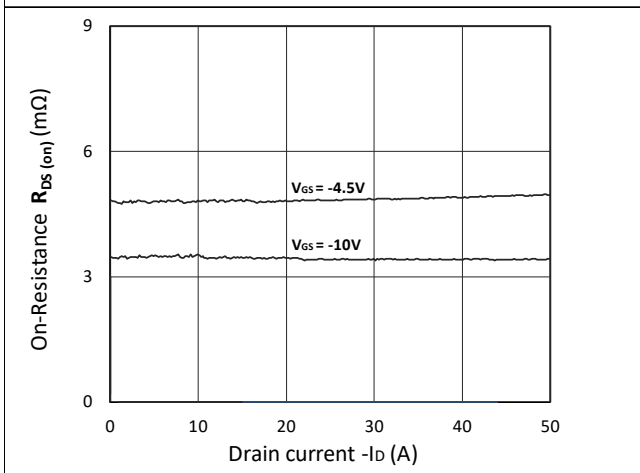
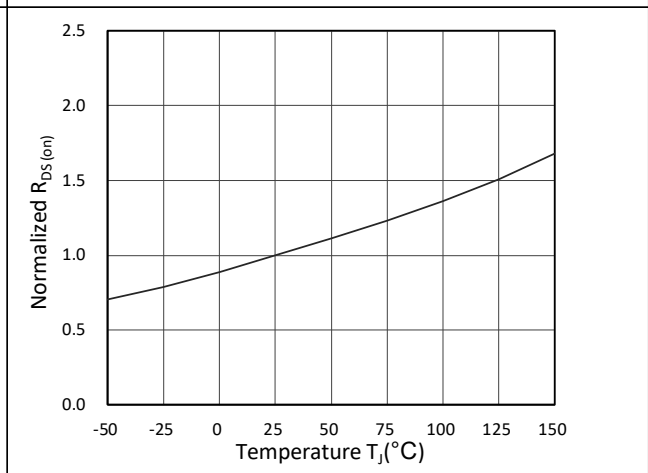


Figure 3. Forward Characteristics of Reverse


 Figure 4. $R_{DS(ON)}$ vs. V_{GS}

 Figure 5. $R_{DS(ON)}$ vs. I_D

 Figure 6. Normalized $R_{DS(ON)}$ vs. Temperature

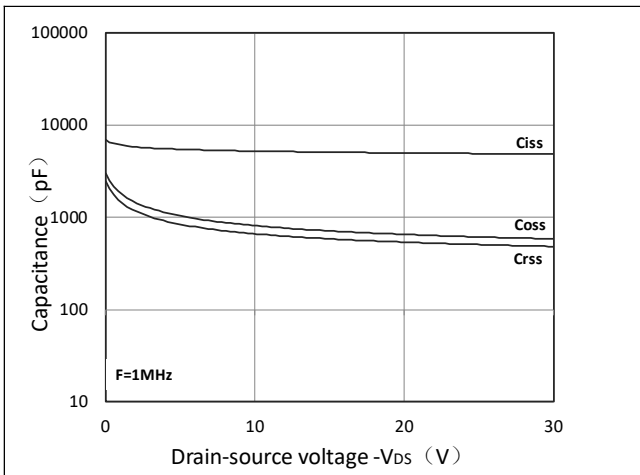


Figure 7. Capacitance Characteristics

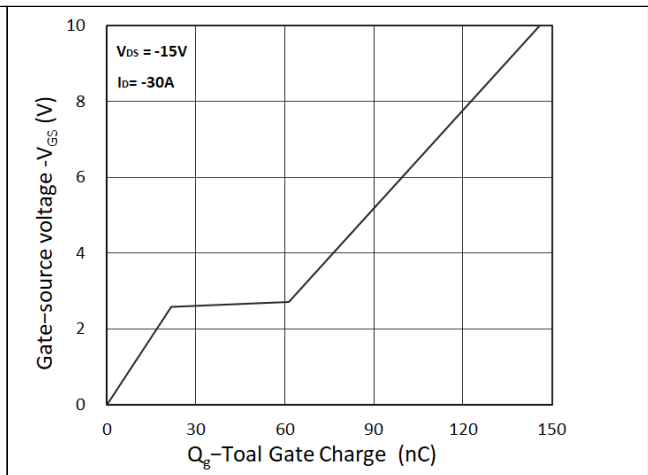


Figure 8. Gate Charge Characteristics

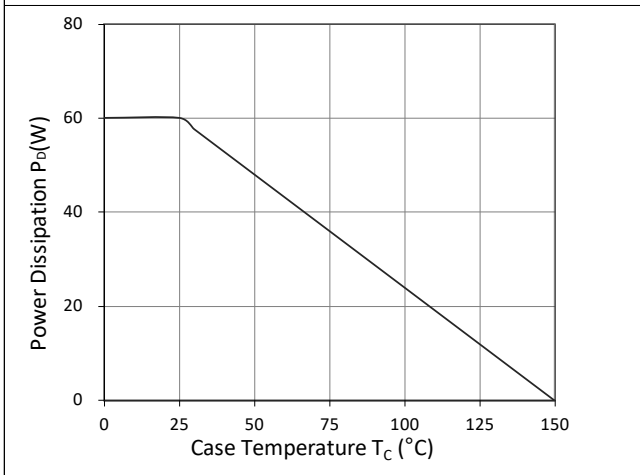


Figure 9. Power Dissipation

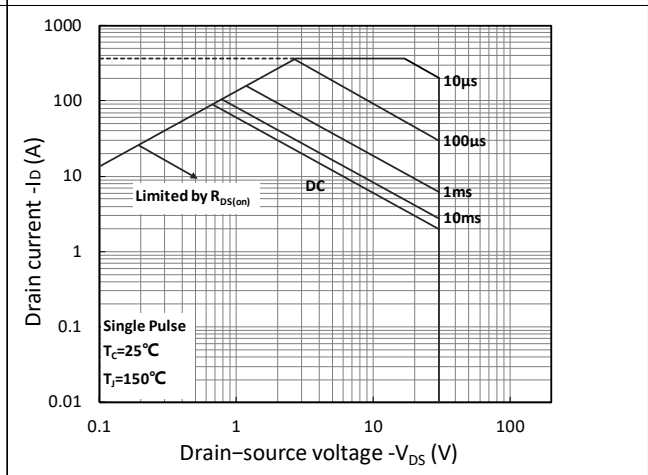


Figure 10. Safe Operating Area

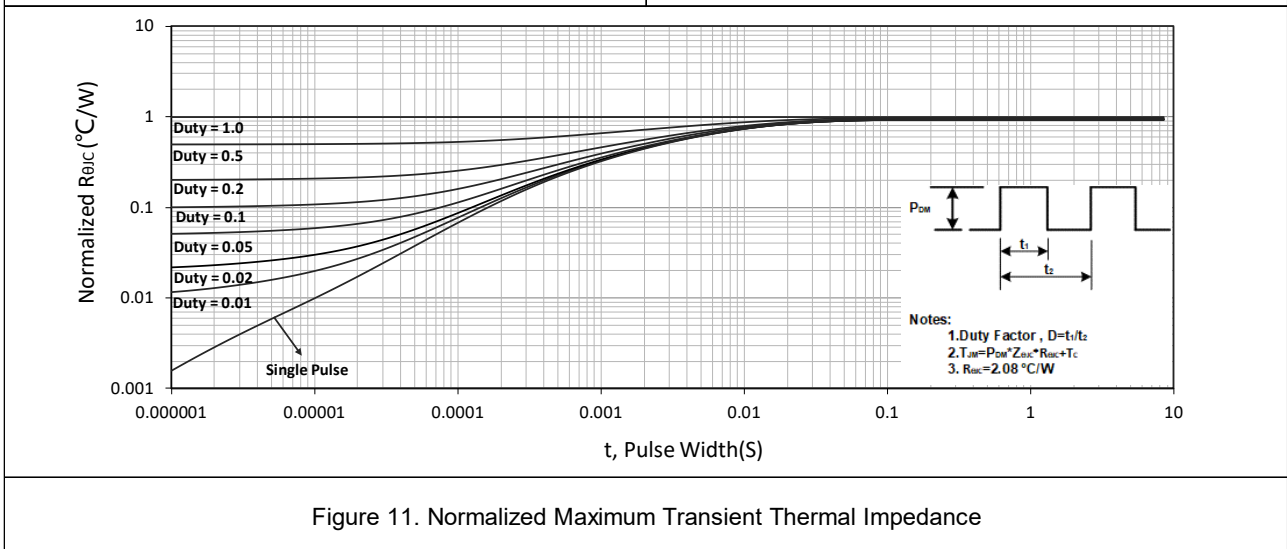


Figure 11. Normalized Maximum Transient Thermal Impedance

Test Circuit

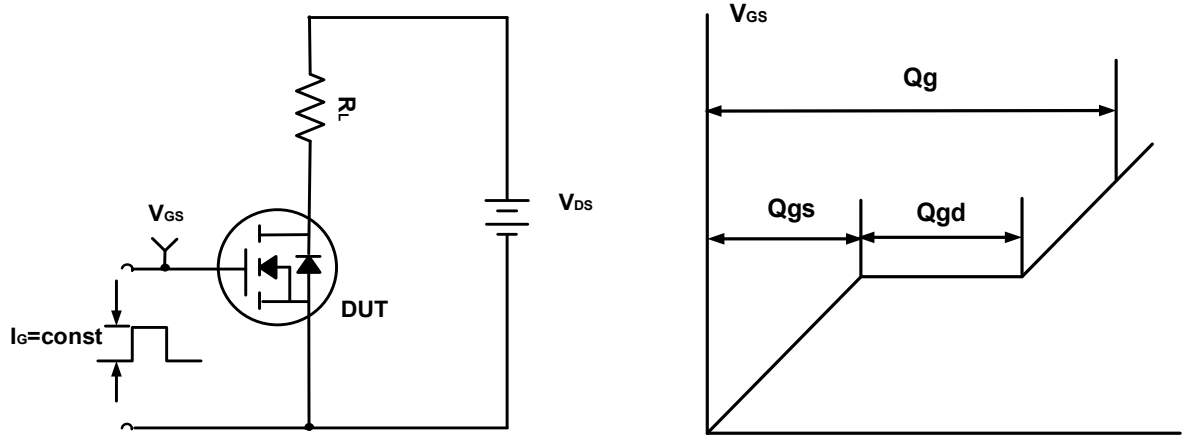


Figure A. Gate Charge Test Circuit & Waveforms

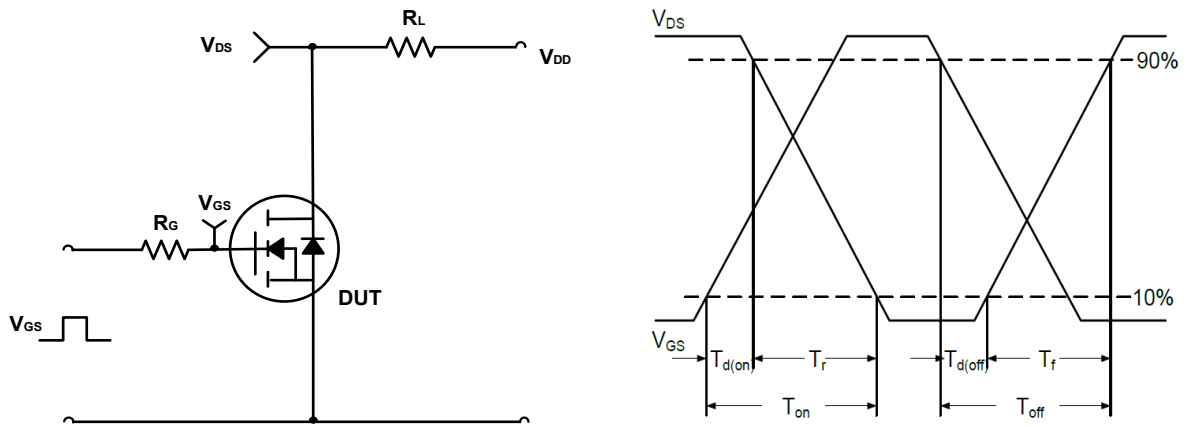


Figure B. Switching Test Circuit & Waveforms

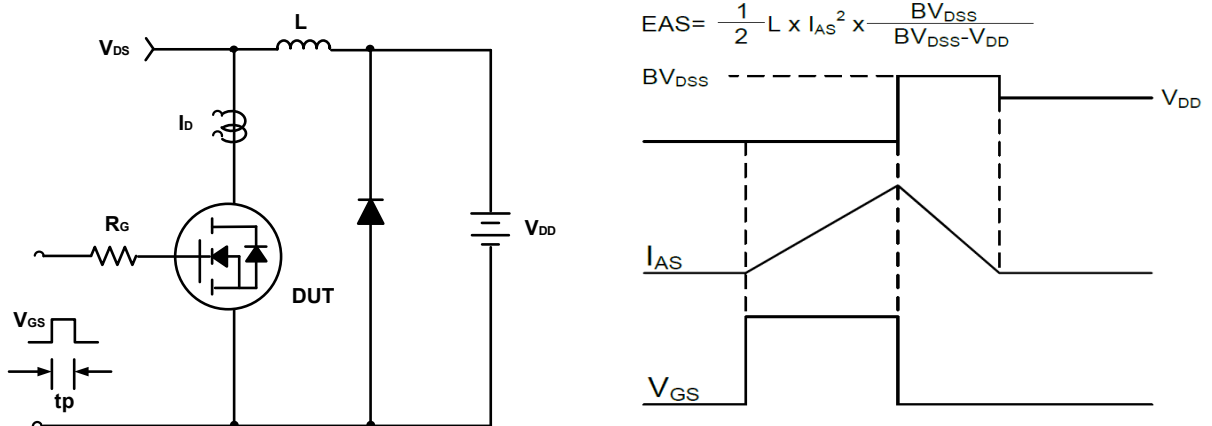
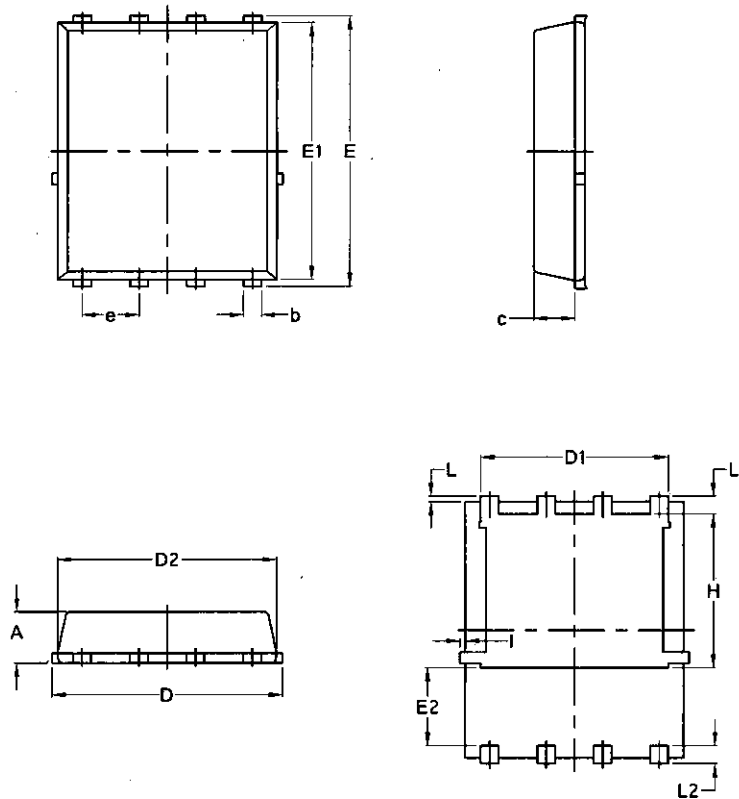


Figure C. Unclamped Inductive Switching Circuit & Waveforms

Package Mechanical Data-DFN5*6-8L-JQ Single


Symbol	Common			
	mm		Inch	
	Min	Max	Min	Max
A	1.03	1.17	0.0406	0.0461
b	0.34	0.48	0.0134	0.0189
c	0.824	0.0970	0.0324	0.082
D	4.80	5.40	0.1890	0.2126
D1	4.11	4.31	0.1618	0.1697
D2	4.80	5.00	0.1890	0.1969
E	5.95	6.15	0.2343	0.2421
E1	5.65	5.85	0.2224	0.2303
E2	1.60	/	0.0630	/
e	1.27 BSC		0.05 BSC	
L	0.05	0.25	0.0020	0.0098
L1	0.38	0.50	0.0150	0.0197
L2	0.38	0.50	0.0150	0.0197
H	3.30	3.50	0.1299	0.1378
I	/	0.18	/	0.0070