



Features

- Split Gate Trench MOSFET technology
- Excellent package for heat dissipation
- High density cell design for low $R_{DS(ON)}$

Product Summary

BVDSS	RDSON	ID
100V	7.3 mΩ	80A

Applications

- DC-DC Converters
- Power management functions
- Synchronous-rectification applications

TO252 Pin Configuration

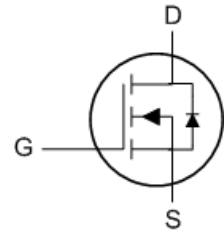
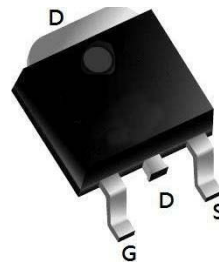

Absolute Maximum Ratings

Symbol	Parameter	Max.	Units
V_{DSS}	Drain-Source Voltage	100	V
V_{GSS}	Gate-Source Voltage	±20	V
I_D	Continuous Drain Current	$T_C = 25^\circ\text{C}$	80
		$T_C = 100^\circ\text{C}$	49
I_{DM}	Pulsed Drain Current ^{note1}	300	A
E_{AS}	Single Pulsed Avalanche Energy ^{note2}	90	mJ
P_D	Power Dissipation	$T_C = 25^\circ\text{C}$	97
$R_{\theta JC}$	Thermal Resistance, Junction to Case	1.3	°C/W
T_J, T_{STG}	Operating and Storage Temperature Range	-55 to +150	°C

Electrical Characteristics ($T_J=25^{\circ}\text{C}$ unless otherwise specified)

Symbol	Parameter	Test Condition	Min.	Typ.	Max.	Units
Off Characteristic						
$V_{(BR)DSS}$	Drain-Source Breakdown Voltage	$V_{GS}=0V, I_D=250\mu A$	100	-	-	V
I_{DSS}	Zero Gate Voltage Drain Current	$V_{DS}=100V, V_{GS}=0V,$	-	-	1.0	μA
I_{GSS}	Gate to Body Leakage Current	$V_{DS}=0V, V_{GS}= \pm 20V$	-	-	± 100	nA
On Characteristics						
$V_{GS(th)}$	Gate Threshold Voltage	$V_{DS}=V_{GS}, I_D=250\mu A$	1.0	1.6	2.5	V
$R_{DS(on)}$	Static Drain-Source on-Resistance <small>note3</small>	$V_{GS}=10V, I_D=20A$	-	7.3	9.2	m Ω
		$V_{GS}=4.5V, I_D=8A$	-	9	13.5	m Ω
Dynamic Characteristics						
C_{iss}	Input Capacitance	$V_{DS}=50V, V_{GS}=0V,$ $f=1.0MHz$	-	2046	-	pF
C_{oss}	Output Capacitance		-	865	-	pF
C_{rss}	Reverse Transfer Capacitance		-	25	-	pF
Q_g	Total Gate Charge	$V_{DS}=50V, I_D=30A,$ $V_{GS}=10V$	-	39.4	-	nC
Q_{gs}	Gate-Source Charge		-	5.2	-	nC
Q_{gd}	Gate-Drain("Miller") Charge		-	9.8	-	nC
Switching Characteristics						
$t_{d(on)}$	Turn-on Delay Time	$V_{DD}=50V, I_D=25A,$ $R_G=6\Omega, V_{GS}=10V$	-	20	-	ns
t_r	Turn-on Rise Time		-	5.2	-	ns
$t_{d(off)}$	Turn-off Delay Time		-	49	-	ns
t_f	Turn-off Fall Time		-	12	-	ns
Drain-Source Diode Characteristics and Maximum Ratings						
I_S	Maximum Continuous Drain to Source Diode Forward Current		-	-	80	A
I_{SM}	Maximum Pulsed Drain to Source Diode Forward Current		-	-	300	A
V_{SD}	Drain to Source Diode Forward Voltage	$V_{GS}=0V, I_S=30A$	-	-	1	V
t_{rr}	Body Diode Reverse Recovery Time	$T_J=25^{\circ}\text{C},$ $I_F=12A, di/dt=100A/\mu s$	-	49	-	ns
Q_{rr}	Body Diode Reverse Recovery Charge		-	85	-	nC

Notes:1. Repetitive Rating: Pulse Width Limited by Maximum Junction Temperature

2. EAS condition: $T_J=25^{\circ}\text{C}, V_{DD}=50V, V_G=10V, R_G=25\Omega, L=0.5mH, I_{AS}=19A$

3. Pulse Test: Pulse Width $\leq 300\mu s$, Duty Cycle $\leq 0.5\%$

Typical Performance Characteristics

Figure 1: Output Characteristics

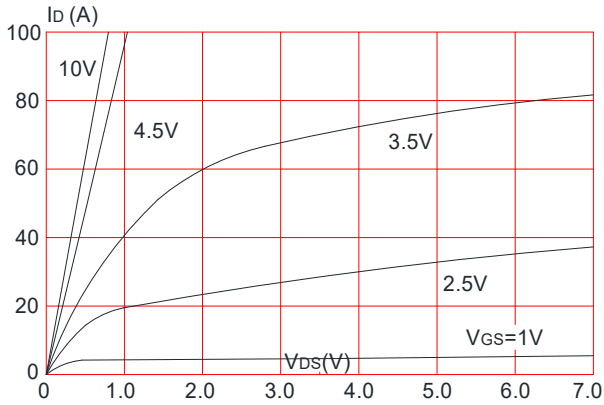

Figure 2: Typical Transfer Characteristics

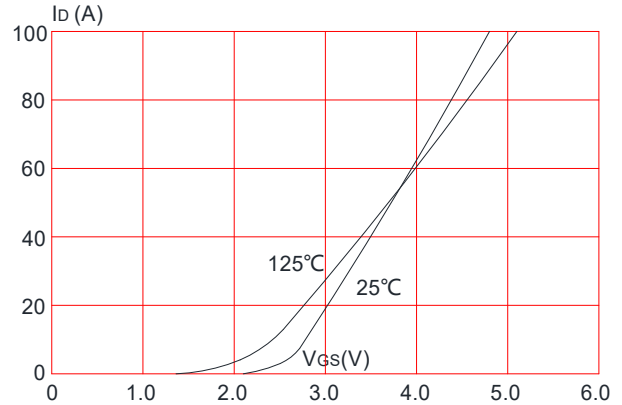

Figure 3: On-resistance vs. Drain Current

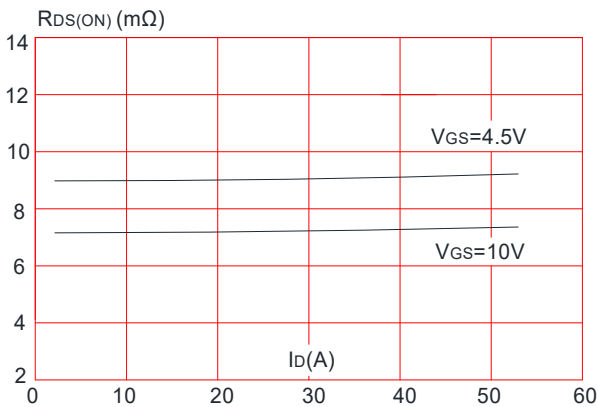

Figure 4: Body Diode Characteristics

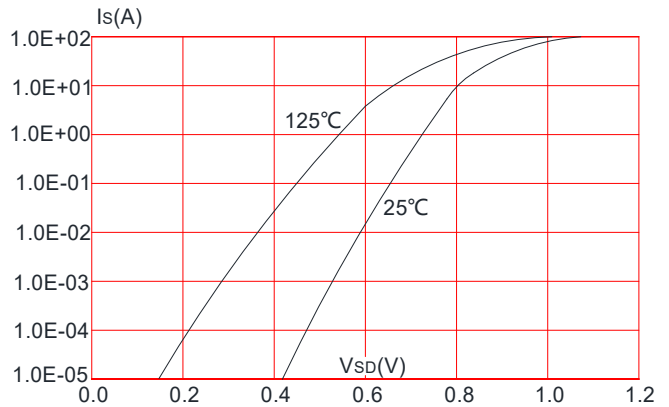

Figure 5: Gate Charge Characteristics

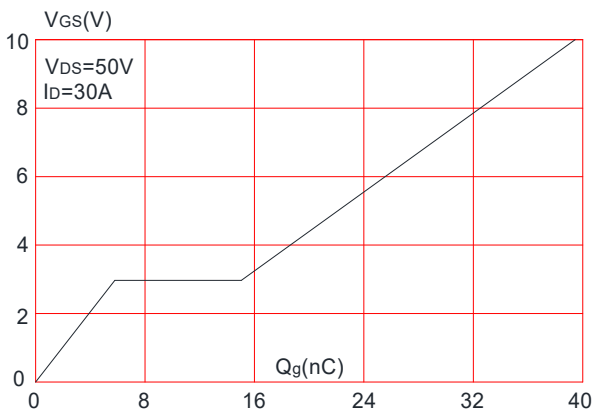

Figure 6: Capacitance Characteristics

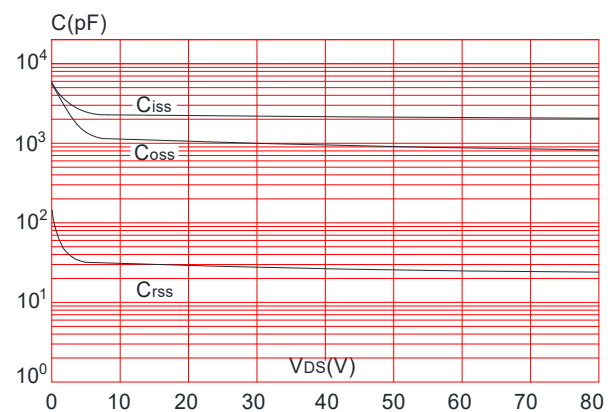
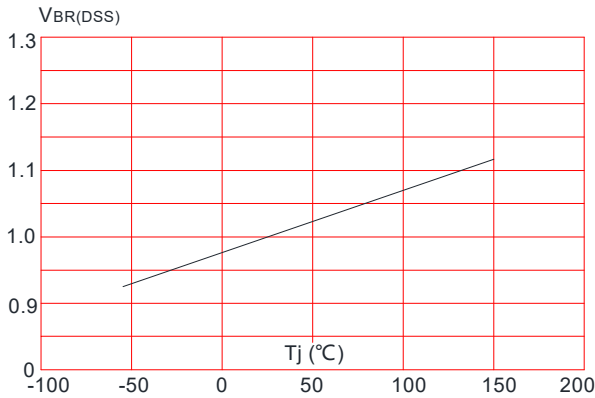
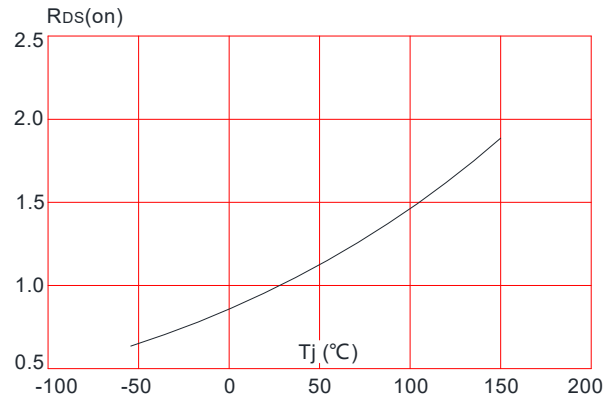
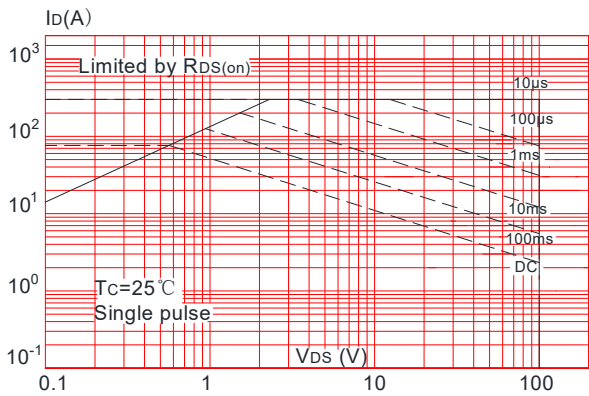
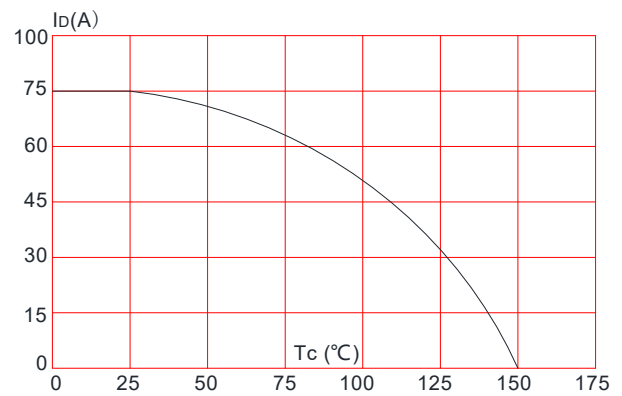
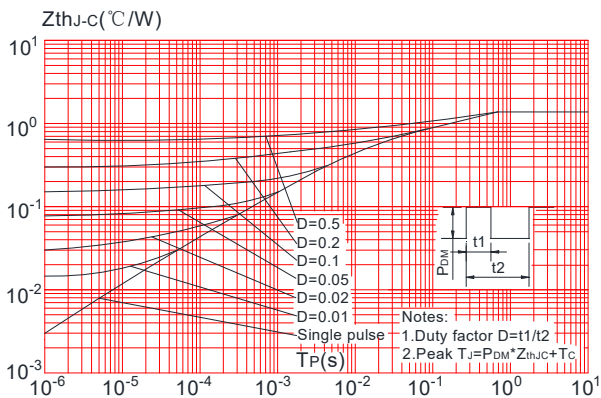
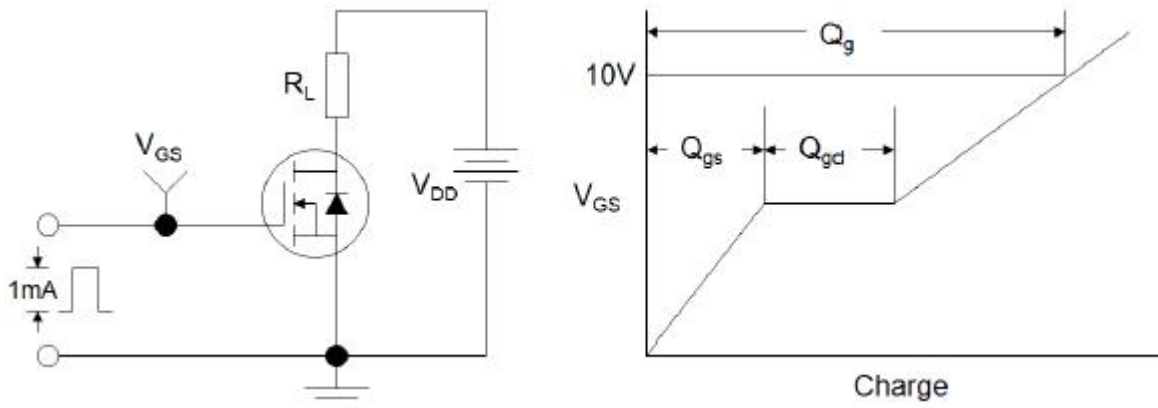
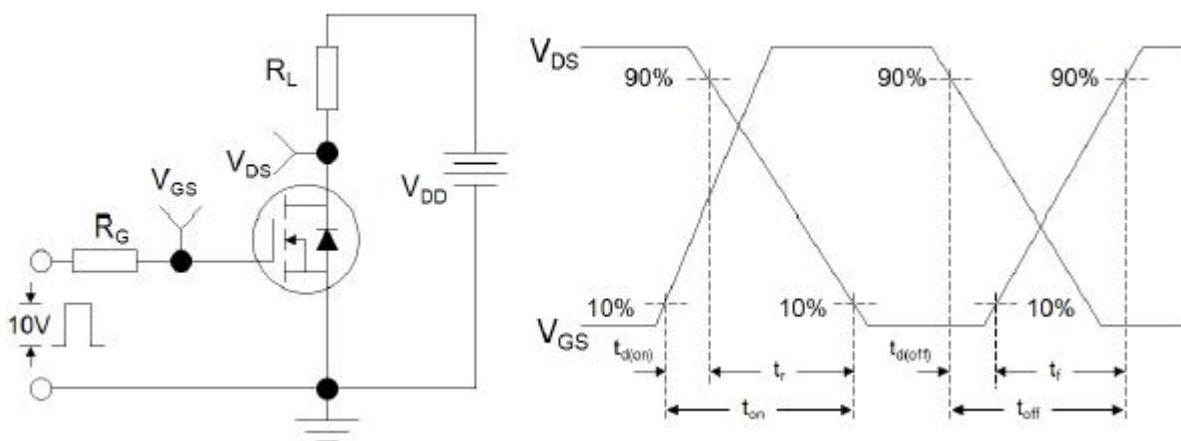
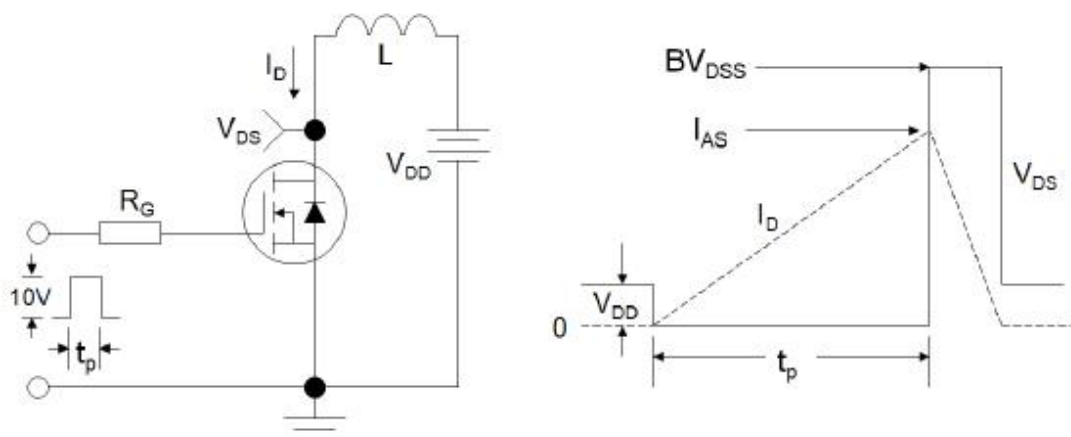
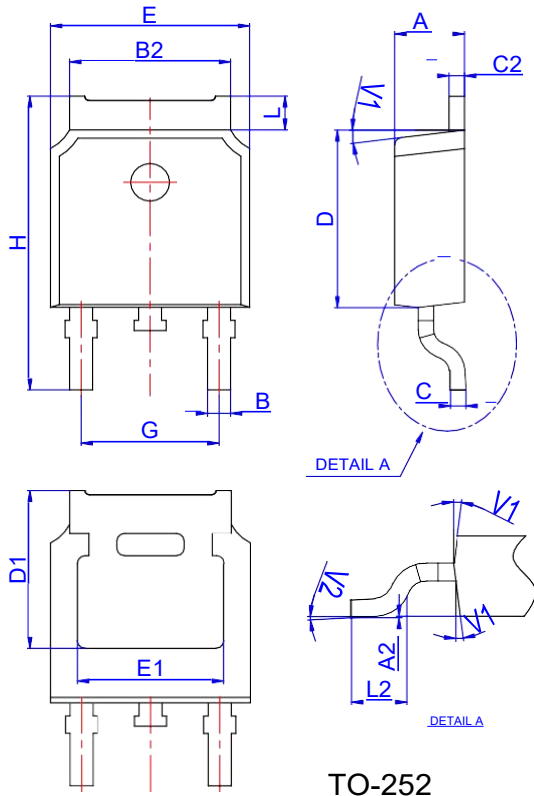
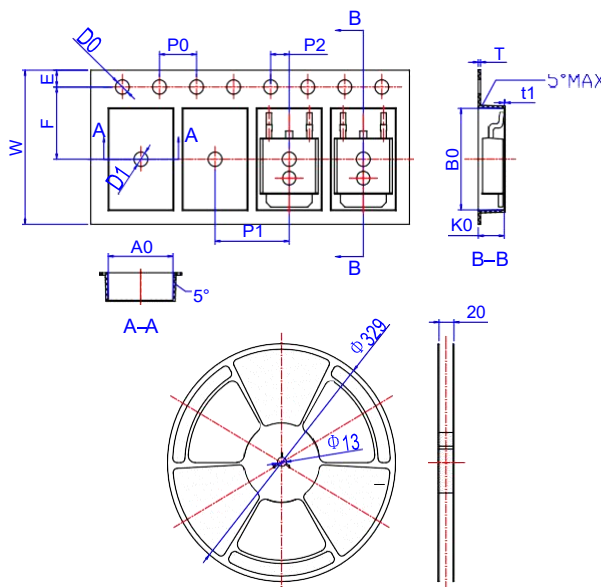

Figure 7: Normalized Breakdown Voltage vs. Junction Temperature

Figure 8: Normalized on Resistance vs. Junction Temperature

Figure 9: Maximum Safe Operating Area

Figure 10: Maximum Continuous Drain Current vs. Case Temperature

Figure.11: Maximum Effective Transient Thermal Impedance, Junction-to-Case

Test Circuit

Figure1:Gate Charge Test Circuit & Waveform

Figure 2: Resistive Switching Test Circuit & Waveforms

Figure 3:Unclamped Inductive Switching Test Circuit & Waveforms

Package Mechanical Data TO252

Ref.	Dimensions					
	Millimeters			Inches		
	Min.	Typ.	Max.	Min.	Typ.	Max.
A	2.10		2.50	0.083		0.098
A2	0		0.10	0		0.004
B	0.66		0.86	0.026		0.034
B2	5.18		5.48	0.202		0.216
C	0.40		0.60	0.016		0.024
C2	0.44		0.58	0.017		0.023
D	5.90		6.30	0.232		0.248
D1	5.30REF			0.209REF		
E	6.40		6.80	0.252		0.268
E1	4.63			0.182		
G	4.47		4.67	0.176		0.184
H	9.50		10.70	0.374		0.421
L	1.09		1.21	0.043		0.048
L2	1.35		1.65	0.053		0.065
V1		7°			7°	
V2	0°		6°	0°		6°

Reel Specification-TO-252-4R

Ref.	Dimensions					
	Millimeters			Inches		
	Min.	Typ.	Max.	Min.	Typ.	Max.
W	15.90	16.00	16.10	0.626	0.630	0.634
E	1.65	1.75	1.85	0.065	0.069	0.073
F	7.40	7.50	7.60	0.291	0.295	0.299
D0	1.40	1.50	1.60	0.055	0.059	0.063
D1	1.40	1.50	1.60	0.055	0.059	0.063
P0	3.90	4.00	4.10	0.154	0.157	0.161
P1	7.90	8.00	8.10	0.311	0.315	0.319
P2	1.90	2.00	2.10	0.075	0.079	0.083
A0	6.85	6.90	7.00	0.270	0.271	0.276
B0	10.45	10.50	10.60	0.411	0.413	0.417
K0	2.68	2.78	2.88	0.105	0.109	0.113
T	0.24		0.27	0.009		0.011
t1	0.10			0.004		
10P0	39.80	40.00	40.20	1.567	1.575	1.583